

Ø16mm XA Series

Ø22mm XW Series

SEMI S2 Compliant EMO Switches and Switch Guards

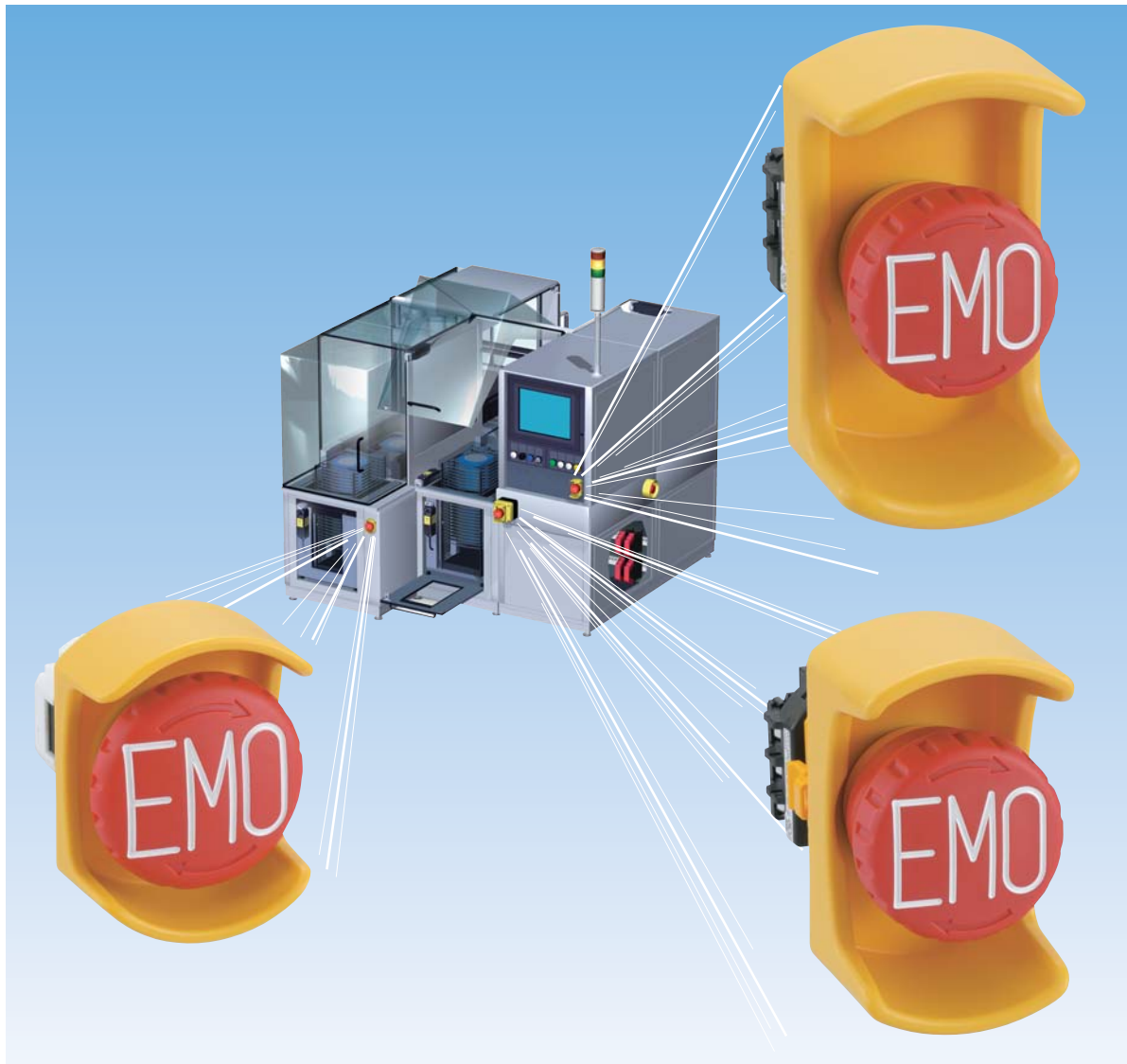

# ø16mm XA Series / ø22mm XW Series SEMI Emergency Off (EMO) Switches

**New**

XA and XW series emergency stop switches are now available with EMO markings. When used in combination with switch guards ensures compliance to SEMI S2 standards.

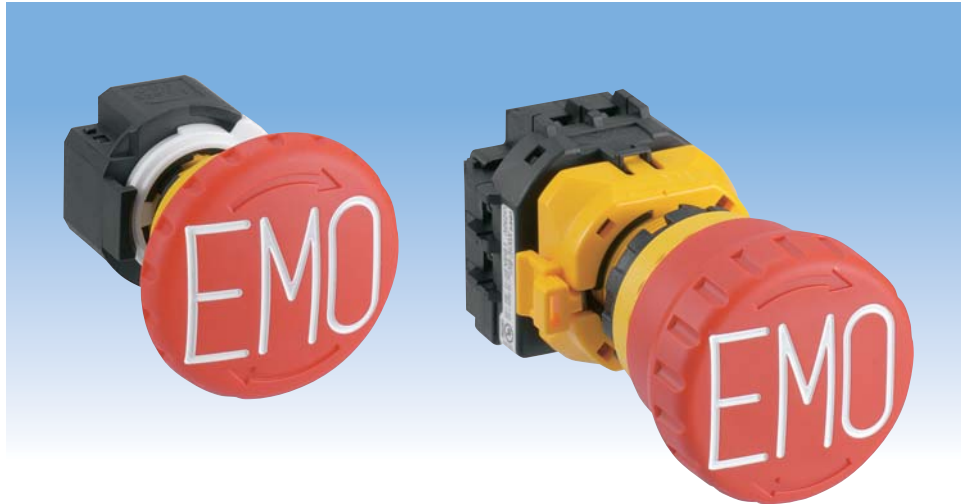

## < Structure and Features >

### ø16mm XA Series

World's First

- Up to four contacts
- Only 27.9 mm deep behind the panel for any number of contacts

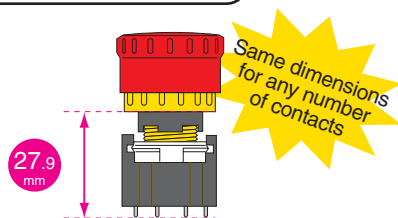

### ø22mm XW Series

World's Shortest

- Shortest for four-contact type
- Only 48.7 mm deep behind the panel for any number of contacts, reducing space.

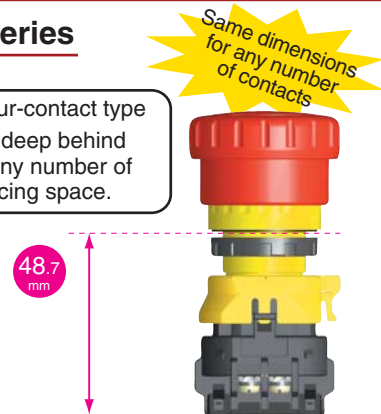

### Safe Break Action

World's First

When the contact block is detached from the operator, the NC contact opens (OFF).

Detaching the Contact Block

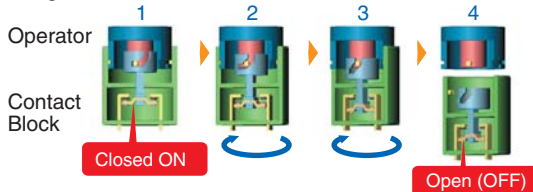

When the contact block is detached from the operator, the cam directly opens the NC main contacts (contacts are off).

### Direct Opening Action

All normally closed contact elements of an emergency stop devices shall have a direct opening action (positive opening action), according to annex K of IEC 60947-5-1. (IEC 60947-5-5; 5.2)  
Achievement of contact separation (of a contact element) of the switch actuator through non-resilient members (for example not dependent upon springs) (IEC 60947-5-1; Annex K)

### Safety Lock Mechanism

The emergency stop signal shall be maintained until the emergency stop device is reset (disengaged). (IEC 60947-5-5; 6.2)

### Safety Potential Structure

**New**

2nd-generation

Normal Status      Latched

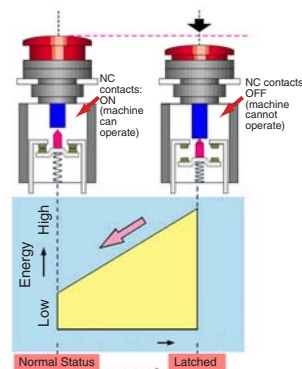

NC contacts: ON (machine can operate)

3rd-generation (Safety Potential Structure)

Normal Status      Latched

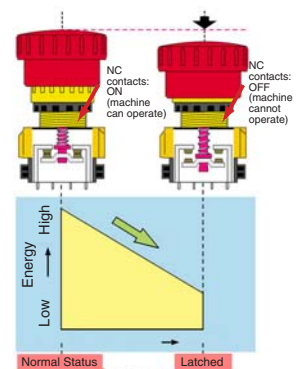

NC contacts: OFF (machine cannot operate)

With the XA and XW emergency stop switches, the potential energy level of the latched status is lower than that of the normal status. In the event the contact block is damaged due to excessive shocks, the NC contacts will turn off, thus leading to safety by stopping the machine.

# SEMI S2 Compliant Switches / Switch Guards

*New*



The combination of EMO switch and switch guard can be used with the FB series control boxes. For details, see the FB series control box catalog (EP1132).

The combination of IDEC's EMO switch guards and emergency stop switches are approved by TÜV Rheinland for compliance with SEMI S2 standards.

XA9Z-KG1

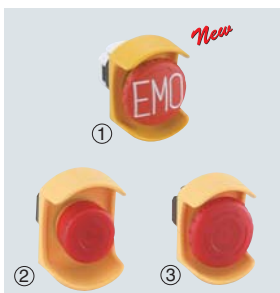

HW9Z-KG3



HW9Z-KG4

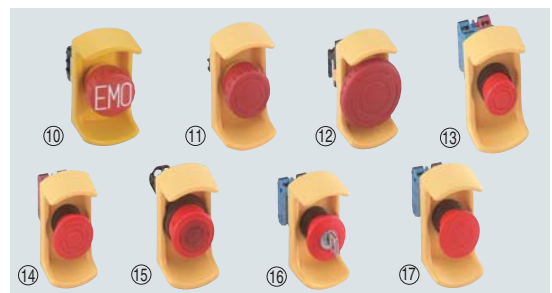

## SEMI S2-compliant Combinations

EMO Switch Guard	Applicable Emergency Stop Switches
XA9Z-KG1	①: XA1E-BV4****-EMO; ②: XA1E-BV3, XA1E-LV3; ③: XA1E-BV4, XA1E-LV4
HW9Z-KG3	④: XW1E-BV4****-EMO; ⑤: XW1E-BV4, XW1E-LV4, XW1E-TV4; ⑥: HW1B-V3; ⑦: HW1B-V4; ⑧: HW1B-X4; ⑨: HW1B-Y2
HW9Z-KG4	⑩: XW1E-BV4****-EMO; ⑪: XW1E-BV4, XW1E-LV4, XW1E-TV4; ⑫: XW1E-BV5; ⑬: HW1B-V3; ⑭: HW1B-V4; ⑮: HW1E-BV4, HW1B-LV4; ⑯: HW1B-X4; ⑰: HW1B-Y2

Note: Numbers in the circle refer to the pictures of the corresponding control units shown above.

## About SEMI

SEMI is an international industry association whose member companies produce materials, equipment, and related technology for manufacturing semiconductor, flat panel display (FPD), and micro-electromechanical systems (MEMS) products. The SEMI safety guideline was published for the semiconductor industry and it is observed with the same importance as standards.

SEMI S2-0706, 12.1 describes as follows; "The equipment should have an 'emergency off' (EMO) circuit. The EMO actuator (e.g., button), when activated, should place the equipment into a safe shutdown condition, without generating any additional hazard to personnel or the facility." Because the semiconductor environment involves solvents and chemicals in many cases, some of which are toxic, interrupting the power source may cause secondary accidents. SEMI safety guideline requires the installation of an emergency off switch which disconnects only the part responsible for the hazardous situation, and maintains the functions of safety-related devices (e.g., smoke detectors, gas/water leak detectors, pressure measurement devices, etc.).

Emergency off buttons should be located or guarded to minimize accidental activation (SEMI S2-0706, 12.5.1). The emergency off button should be red and mushroom shaped. A yellow background for the EMO should be provided (SEMI S2-0706, 12.3).

- Location of EMO switches on semiconductor manufacturing equipment  
Acceptance criteria: controls should not be located above 1638 mm (64.5 in.) or below 838 mm (33 in.) (SEMI S8-0705, 9.1.2).
- No operation or regularly scheduled maintenance location should require more than 3 m (10 feet) travel to an EMO button (S2-0706, 12.5.2).

EMO button  $\longleftrightarrow$  (3 m maximum) Operator  $\longleftrightarrow$  (3 m maximum) EMO button

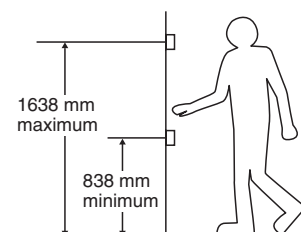

# ø16 XA Series SEMI EMO Switches

## ø16mm XA Series EMO Switches

**The World's First ø16 mm, 4-contact Emergency Stop Switch.**  
**Compact size—only 27.9 mm deep behind the panel.**

- Lead-free, RoHS compliant.
- The depth behind the panel is only 27.9 mm for 1 to 4 contacts.
- IDEC's original "Safe break action" ensures that the contacts open when the contact block is detached from the operator.
- 1 to 4NC main contacts and 1NO monitor contact
- Push-to-lock, Pull or Turn-to-reset operator
- Direct opening action mechanism (IEC60947-5-5, 5.2, IEC60947-5-1, Annex K)
- Safety lock mechanism (IEC60947-5-5, 6.2)
- Degree of protection IP65 (IEC60529)



### Types

Description	NC Main Contact	NO Monitor Contact	Ordering Type No.
ø40mm Mushroom	1NC	—	XA1E-BV401RH-EMO
	2NC	—	XA1E-BV402RH-EMO
	3NC	—	XA1E-BV403RH-EMO
	4NC	—	XA1E-BV404RH-EMO
	1NC	1NO	XA1E-BV411RH-EMO
	2NC	1NO	XA1E-BV412RH-EMO
	3NC	1NO	XA1E-BV413RH-EMO

- Button color is bright red (RH).
- For detailed specifications and operation of emergency stop switches, see a separate catalog for the XA/XW emergency stop switches (EP1050).

### Contact Ratings (NC main contacts/NO monitor contact)

Rated Insulation Voltage (Ui)				300V		
Rated Current (Ith)				5A		
Rated Operating Voltage (Ue)				30V	125V	250V
Rated Operating Current	Main Contacts	AC 50/60 Hz	Resistive Load (AC-12)	—	3A	3A
			Inductive Load (AC-15)	—	1.5A	1.5A
		DC	Resistive Load (DC-12)	2A	0.4A	0.2A
			Inductive Load (DC-13)	1A	0.22A	0.1A
	Monitor Contacts	AC 50/60 Hz	Resistive Load (AC-12)	—	1.2A	0.6A
			Inductive Load (AC-14)	—	0.6A	0.3A
		DC	Resistive Load (DC-12)	2A	0.4A	0.2A
			Inductive Load (DC-13)	1A	0.22A	0.1A

- Minimum applicable load: 5V AC/DC, 1 mA (reference value) (Operating area may vary according to the operating conditions and load types.)
- The rated operating currents are measured at resistive/inductive load types specified in JIS C8201-5-1.

### Dimensions

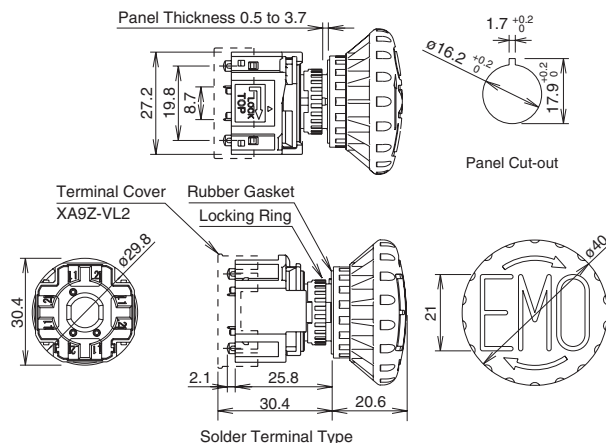

All dimensions in mm.

## ø22mm XW Series EMO Switches

**ø22 mm, 4-contact Emergency Stop Switch. Compact size—only 48.7 mm deep behind the panel.**

- Lead-free, RoHS compliant.
- The depth behind the panel is only 48.7 mm for 1 to 4 contacts
- IDEC's original "Safe break action" ensures that the contacts open when the contact block is detached from the operator.
- 1 to 4NC main contacts and 1 or 2NO monitor contacts
- Push-to-lock, Pull or Turn-to-reset operator
- Direct opening action mechanism (IEC60947-5-5, 5.2, IEC60947-5-1, Annex K)
- Safety lock mechanism (IEC60947-5-5, 6.2)
- Degree of protection IP65 (IEC60529)
- Fingersafe screw terminal (IP20)
- UL, c-UL approved. EN compliant



### Types

Description and Appearance	NC Main Contact	NO Monitor Contact	Ordering Type No.	
			IP20 Fingersafe Terminal	w/Terminal Cover
ø40mm Mushroom	1NC	—	XW1E-BV401MFRH-EMO	XW1E-BV401MRH-EMO
	2NC	—	XW1E-BV402MFRH-EMO	XW1E-BV402MRH-EMO
	3NC	—	XW1E-BV403MFRH-EMO	XW1E-BV403MRH-EMO
	4NC	—	XW1E-BV404MFRH-EMO	XW1E-BV404MRH-EMO
	1NC	1NO	XW1E-BV411MFRH-EMO	XW1E-BV411MRH-EMO
	2NC	1NO	XW1E-BV412MFRH-EMO	XW1E-BV412MRH-EMO
	3NC	1NO	XW1E-BV413MFRH-EMO	XW1E-BV413MRH-EMO
	2NC	2NO	XW1E-BV422MFRH-EMO	XW1E-BV422MRH-EMO

- Button color is bright red (RH).
- For detailed specifications and operation of emergency stop switches, see a separate catalog for the XA/XW emergency stop switches (EP1050).

### Contact Ratings (NC main contacts/NO monitor contact)

Rated Insulation Voltage (Ui)			250V			
Rated Current (Ith)			5A			
Rated Operating Voltage (Ue)			30V	125V	250V	
Rated Operating Current	Main Contacts	AC 50/60 Hz	Resistive Load (AC-12)	—	5A	3A
			Inductive Load (AC-15)	—	3A	1.5A
		DC	Resistive Load (DC-12)	2A	0.4A	0.2A
			Inductive Load (DC-13)	1A	0.22A	0.1A
	Monitor Contacts	AC 50/60 Hz	Resistive Load (AC-12)	—	1.2A	0.6A
			Inductive Load (AC-14)	—	0.6A	0.3A
		DC	Resistive Load (DC-12)	2A	0.4A	0.2A
			Inductive Load (DC-13)	1A	0.22A	0.1A





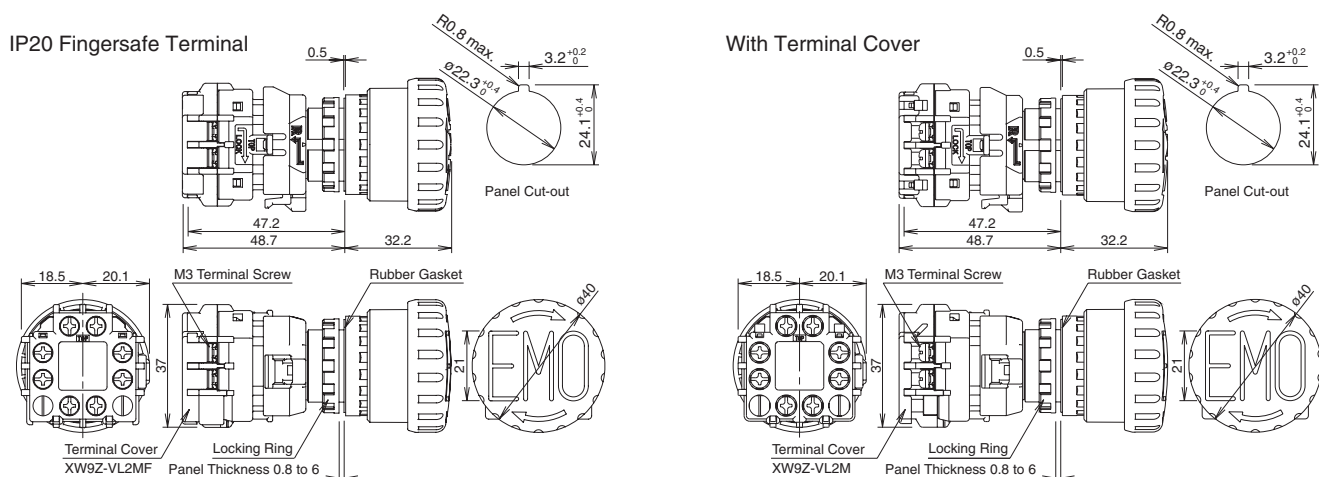

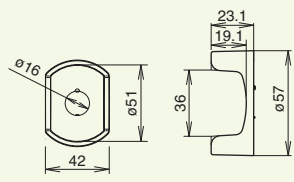

- Minimum applicable load: 5V AC/DC, 1 mA (reference value) (Operating area may vary according to the operating conditions and load types).
- The rated operating currents are measured at resistive/inductive load types specified in JIS C8201-5-1.

### Dimensions

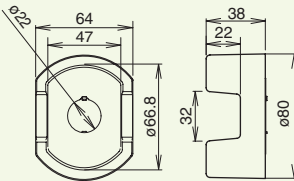

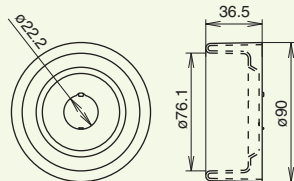
# SEMI EMO Switch Guards

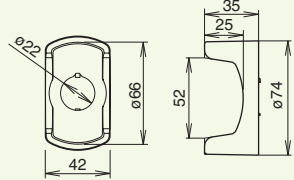
## Types

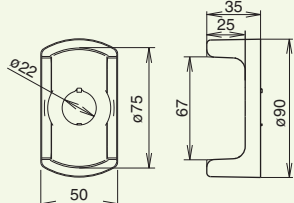
Series	Description & Appearance	Type No.	Specifications	Dimensions (mm)
<b>ø16mm XA</b>	EMO Switch Guard SEMI S2 compliant (Note 1) 	XA9Z-KG1		
<b>ø22mm HW/XW</b>	EMO Switch Guard SEMI S2 compliant (Note 2) 	HW9Z-KG1 (Note 5)		
	EMO Switch Guard SEMI S2 compliant (Note 1) SEMATECH compliant (Note 3) 	HW9Z-KG2 (Note 5)	Polyamide (PA6) Color: Yellow, Munsell 2.5Y8/10 equivalent Degree of protection: IP65 (Note 4)	
	EMO Switch Guard SEMI S2 compliant (Note 1) 	HW9Z-KG3		
	EMO Switch Guard SEMI S2 compliant (Note 1) SEMATECH compliant (Note 3) 	HW9Z-KG4		

Note 1: The combination of IDEC's emergency stop switches and EMO switch guards are approved by TÜV Rheinland for compliance with SEMI S2 standard.

Note 2: SEMI S2-0703, 12.5.1 compliant.

Note 3: SEMATECH Application Guide for SEMI S2-93, 12.4. compliant.

Note 4: Degree of protection IP65 applies to the combination of an emergency stop switch and an EMO switch guard.

Note 5: HW9Z-KG1, HW9Z-KG2, and HW9Z-KG3 can be used with ø29mm or ø40mm mushroom buttons. ø60mm jumbo mushroom buttons cannot be installed.

**Note:**

EMO switch guards have been designed for applications in semiconductor manufacturing equipment only. Do not use EMO switch guards with emergency stop switches which are installed on machine tools or food processing machines. (Machinery Directive of the European Commission and IEC 60204-1 require that emergency stop switches be installed in a readily accessible area, and the usage of switch guards is not permitted.)

# SEMI EMO Switch Guards

## Panel Cut-out

•  $\phi 16$  mm

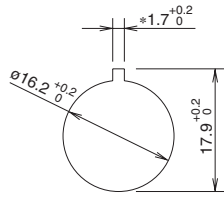

The  $*1.7^{+0.2}_0$  recess is for preventing rotation and not necessary when anti-rotation is not used.

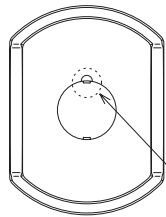

Projection

•  $\phi 22$  mm

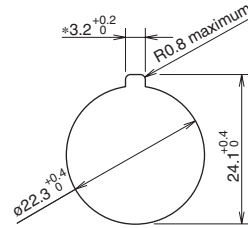

The  $*3.2^{+0.2}_0$  recess is for preventing rotation and not necessary when anti-rotation is not used.

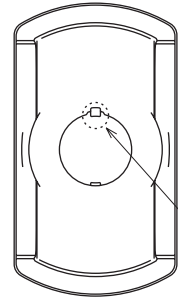

Projection

When anti-rotation is not required or when the panel cut-out does not have anti-rotation recess, remove the projection using pliers.

## Installation

•  $\phi 16$  mm

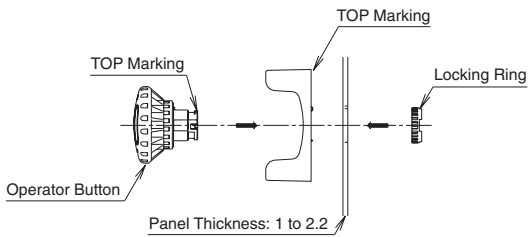

To tighten the locking ring, use locking ring wrench MT-100 and tighten to a torque of 0.88 N·m.

•  $\phi 22$  mm

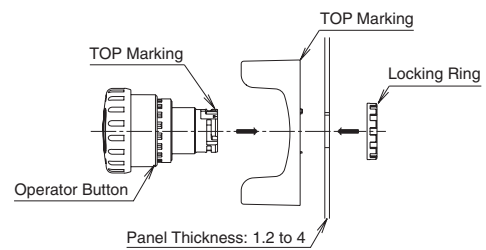

To tighten the locking ring, use locking ring wrench MW9Z-T1 and tighten to a torque of 2.0 N·m.

All dimensions in mm.

## EMO Sticker

Type No.: HW9Z-EMO-NPP  
Color: Yellow (red legend)  
Package Quantity: 10



## $\phi 22$ mm HW Series EMO Switch (Pushlock Turn Reset Switch)

Appearance	Contact Arrangement	Type No.	Button Color
	1NC	HW1B-V401R-EMO	Red only
	1NO-1NC	HW1B-V411R-EMO	
	2NC	HW1B-V402R-EMO	
	2NO-2NC	HW1B-V422R-EMO	

• For detailed specifications and operation of the pushlock turn reset switch, see the HW series catalog.

## Dimensions

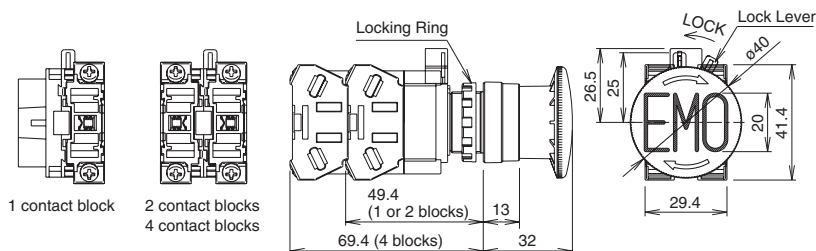

All dimensions in mm.

## ø16mm XA Series / ø22mm XW Series Emergency Stop Switches

### ø16mm XA Series

The world's first ø16mm, 4-contact emergency stop switch—only 27.9mm deep behind the panel.

- Contact: Main 1NC to 4NC, Monitor 1NO
- Rated Operating Current: Main contacts  
AC: 250V, 3A (resistive load)  
DC: 250V, 0.2A (resistive load)  
Monitor contacts  
AC: 250V, 0.6A (resistive load)  
DC: 250V, 0.2A (resistive load)
- Illumination Ratings: 24V AC/DC, 11 mA



### ø22mm XW Series

The world's first ø22mm, 4-contact emergency stop switch—only 48.7 mm deep behind the panel.

- Contact: Main 1NC to 4NC, Monitor 1NO to 2NO
- Rated Operating Current: Main contacts  
AC: 250V, 3A (resistive load)  
DC: 250V, 0.2A (resistive load)  
Monitor contacts  
AC: 250V, 0.6A (resistive load)  
DC: 250V, 0.2A (resistive load)
- Illumination Ratings: 24V AC/DC, 15 mA



## LW Series Flush Silhouette Switches

Flush bezel projects only 2 mm from front of the panel.

ø28mm round and 28mm square black plastic bezels. Round metal bezels are also available.

- ø25.3mm round panel cut-out, 24.5mm square panel cut-out.
- Collective mounting is possible.
- Separate type control units with a locking lever enable easy installation even when mounted collectively.
- Gold-clad silver or silver contacts.
- IP65 protection (IEC 60529)
- UL recognized and CSA certified. EN compliant.



Specifications and other descriptions in this catalog are subject to change without notice.



## IDEC CORPORATION

7-31, Nishi-Miyahara 1-Chome, Yodogawa-ku, Osaka 532-8550, Japan  
Tel: +81-6-6398-2571, Fax: +81-6-6392-9731  
E-mail: products@idec.co.jp

**IDEC CORPORATION (USA)**  
1175 Elko Drive, Sunnyvale, CA 94089-2209, USA  
Tel: +1-408-747-0550 / (800) 262-IDECE (4332)  
Fax: +1-408-744-9055 / (800) 635-6246  
E-mail: opencontact@idec.com

**IDEC CANADA LIMITED**  
Unit 22-151, Brunel Road, Mississauga, Ontario,  
L4Z 1X3, Canada  
Tel: +1-905-890-8561, Toll Free: (888) 317-4332  
Fax: +1-905-890-8562  
E-mail: sales@ca.idec.com

**IDEC AUSTRALIA PTY. LTD.**  
2/3 Macro Court, Rowville, Victoria 3178, Australia  
Tel: +61-3-9763-3244, Toll Free: 1800-68-4332  
Fax: +61-3-9763-3255  
E-mail: sales@au.idec.com

**IDEC ELECTRONICS LIMITED**  
Unit 2, Beechwood, Chineham Business Park,  
Basingstoke, Hampshire RG24 8WA, UK  
Tel: +44-1256-321000, Fax: +44-1256-327755  
E-mail: sales@uk.idec.com

**IDEC ELEKTROTECHNIK GmbH**  
Wendenstrasse 331, 20537 Hamburg, Germany  
Tel: +49-40-25 30 54 - 0, Fax: +49-40-25 30 54 - 24  
E-mail: service@idec.de

**IDEC (SHANGHAI) CORPORATION**  
Room 608-609, 6F, Gangtai Plaza, No. 700,  
Yan'an East Road, Shanghai 200001, PRC  
Tel: +86-21-5353-1000, Fax: +86-21-5353-1263  
E-mail: idec@cn.idec.com

**IDEC (BEIJING) CORPORATION**  
Room 211B, Tower B, The Grand Pacific Building,  
8A Guanghua Road, Chaoyang District,  
Beijing 100026, PRC  
Tel: +86-10-6581-6131, Fax: +86-10-6581-5119

**IDEC (SHENZHEN) CORPORATION**  
Unit AB-3B2, Tian Xiang Building, Tian'an Cyber Park,  
Fu Tian District, Shenzhen, Guang Dong 518040, PRC  
Tel: +86-755-8356-2977, Fax: +86-755-8356-2944

**IDEC IZUMI (H.K.) CO., LTD.**  
Unit 1505-07, DCH Commercial Centre No. 25,  
Westlands Road, Quarry Bay, Hong Kong  
Tel: +852-2803-8989, Fax: +852-2565-0171  
E-mail: info@hk.idec.com

**IDEC TAIWAN CORPORATION**  
8F-1, No. 79, Hsin Tai Wu Road, Sec. 1,  
Hsi-Chih, Taipei County, Taiwan  
Tel: +886-2-2698-3929, Fax: +886-2-2698-3931  
E-mail: service@tw.idec.com

**IDEC IZUMI ASIA PTE. LTD.**  
No. 31, Tannery Lane #05-01, Dragon Land  
Building, Singapore 347788  
Tel: +65-6746-1155, Fax: +65-6844-5995  
E-mail: info@sg.idec.com

www.idec.com

Cat. No. EP1166-0 MARCH 2007 PRINTED IN JAPAN

(07/03/26)