

# OpenNet Controller



FC3A-CP2K  
FC3A-CP2S

## Electrical Specifications

FC3A-CP2K, -CP2KM*	High-speed counter sink output
FC3A-CP2S, -CP2SM*	High-speed counter source output
Rated Voltage	24V DC (19-30V DC, including ripple)
Maximum Input Current	1.5A at 24V DC
Reverse Polarity Protection	Prevents damage if incorrectly wired.
Operating Temperature	0 to +55°C
Storage Temperature	-25 to +70°C
Relative Humidity	30 to 95% (non-condensing)
Vibration Resistance	10 to 57 Hz, amplitude 0.075mm 57 to 150 Hz 9.8 m/sec <sup>2</sup> 10 sweep cycles/axis (IEC 1131)
Shock Resistance	147 m/sec <sup>2</sup> , 11 ms 3 shocks each in 3 axes (IEC 1131)
Dielectric Strength	Between power terminal and FG: 500V AC, 1 min Between I/O terminal and FG: 1500V AC, 1 min
Ground	Grounding resistance 100Ω (maximum)
Mounting Style	35mm DIN rail

## Hardware Features

- Digital I/O
  - 8, 16, and 32 point cards
  - 224 inputs and outputs, 480 with expansion power supply
- Analog I/O
  - up to 42 analog inputs or 14 analog outputs
  - 0-5V, 0-10V, ±5V, ±10V, 4-20mA
- Built-In Communications Ports
  - 2 RS232 (programming port, ASCII, printer and modem ready)
  - 1 RS485 (programming port and data link)
- Build-in High-Speed Counter
  - 1 channel, 10kHz, 16-bit resolution
- Memory
  - 16K words (8K steps) user program capacity
  - Flash miniature memory card slot (FC3A-CP2KM/SM\* only)
- Realtime Calendar/Clock, Y2K compliant
- Password Protection
- PID Algorithm

## ONC Capabilities

- Networking
  - ONC capable of communicating with various standard networks:
    - DeviceNet
    - INTERBUS
    - LONWORKS
- Programming Software: WindLDR® 3.0
  - Programs all IDEC PLCs
  - Windows-based (compatible with Windows 3.10, 3.11, Win 95 or Win 98)
- Programming Instructions
  - Transmit/Receive

- Built-in X/Y Conversion
- Sub-Routine Call/Return for Modular Programming
- Square Root
- 16- and 32-bit Math, Add, Sub, Mult, Div
- Data Conversion to/from Dec, Hex, BCD, ASCII
- Block Move
- Summation
- Averaging
- Day of Week Program Scheduling
- Built-in Hayes "AT" command set for modem dialup/pager applications

\*FC3A-CP2KM/SM will be available soon



Powered by IDEC's PS5R Series 50W Power Supply

		PS5R Power Supply
<b>PS5R-D24</b>	<b>Wattage &amp; Current Ratings</b>	50W, 2.1A
	<b>Rating</b>	UL 508 listed
	<b>Mounting</b>	DIN rail mountable
		Standard ONC CPU
<b>General ONC Specifications</b>	<b>Available Instructions</b>	37 basic, 65 advanced (PID, square root, subroutine calls, etc.)
	<b>User Program Capacity</b>	16K words flash memory
	<b>Memory (Miniature Card)</b>	2, 4 and 8MB; 5V type
	<b>Average Scan Time</b>	1 ms or greater
	<b>Input</b>	224 points (I0-I277)
	<b>Output</b>	224 points (Q0-Q277)
	<b>Total I/O Points</b>	Using expansion power supply: 480 I/O points
	<b>Internal Relay</b>	2048 (M0-M2557)
	<b>Special Internal Relay</b>	192 (M8000-M8237)
	<b>Shift Register</b>	256 (R0-R255)
	<b>Timer</b>	256 (T0-T255; 1-sec, 100-msec, 10-msec, 1-msec)
	<b>Counter</b>	256 (C0-C255; adding, dual pulse reversible, up/down selection reversible)
	<b>Data Register</b>	8000 (D0-D7999)
	<b>Link Register</b>	256 master (L1000 - L1317), 168 slave (L100 - L127, L200 - L227, ....., L700 - L727)
	<b>Remote I/O</b>	512 points
	<b>Real-Time Calendar/Clock Runtime</b>	Yes (Y2K compliant)
	<b>Program Protection</b>	Yes (password protected)
<b>External Run/Stop Control</b>	Yes	
<b>Power Failure Protection</b>	Yes	
<b>Self-Diagnostics</b>	Yes	
<b>Auto Start Function</b>	Yes	

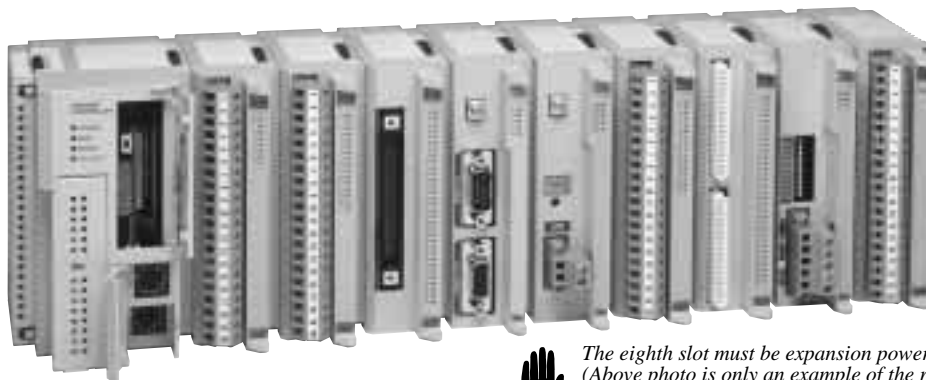

The eighth slot must be expansion power supply module. (Above photo is only an example of the range of available modules.)

## PC Communication

The ONC is programmed by our intuitive WindLDR™ 3.0 software  
 -use RS232 or RS485 ports  
 -upload, download and monitor programs

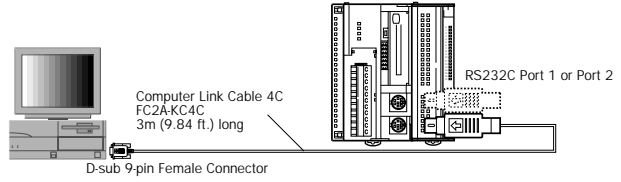

For RS485 programming, use FC2A-KC6C cable.

## Data Link - Superiority in Networking

Connect up to 32 ONC, Micro3, FA Series PLCs or the HG Series operator interface on the data link network.

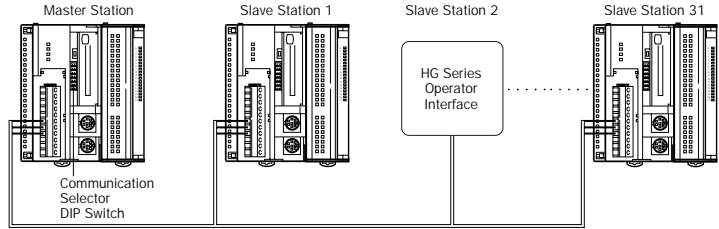

## Computer Link - Power & Versatility

Connect 32 ONCs on a 1:N computer link system.  
 Upload, download, monitor, and update data.

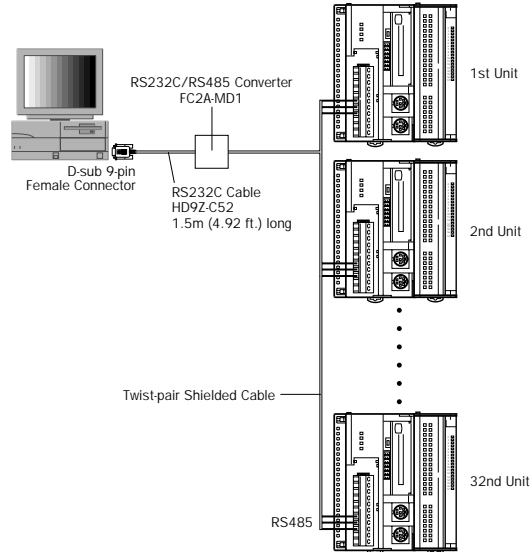

## Communication Flexibility

Easy connections to any R232C equipment through the user defined RS232C port 1 or 2.  
 Built-in Hayes "AT" command set for direct modem dialup and pager applications.

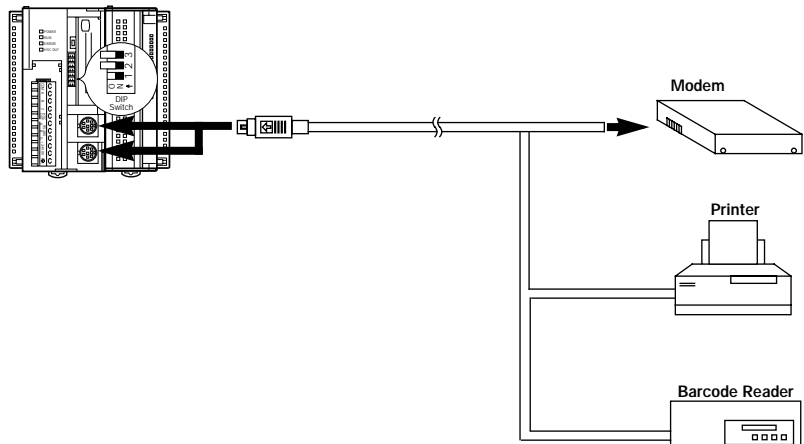

# Network Communication System

The ONC offers versatility and power with the unique capability to interface with standard networks such as INTERBUS, DeviceNet and LonWorks.

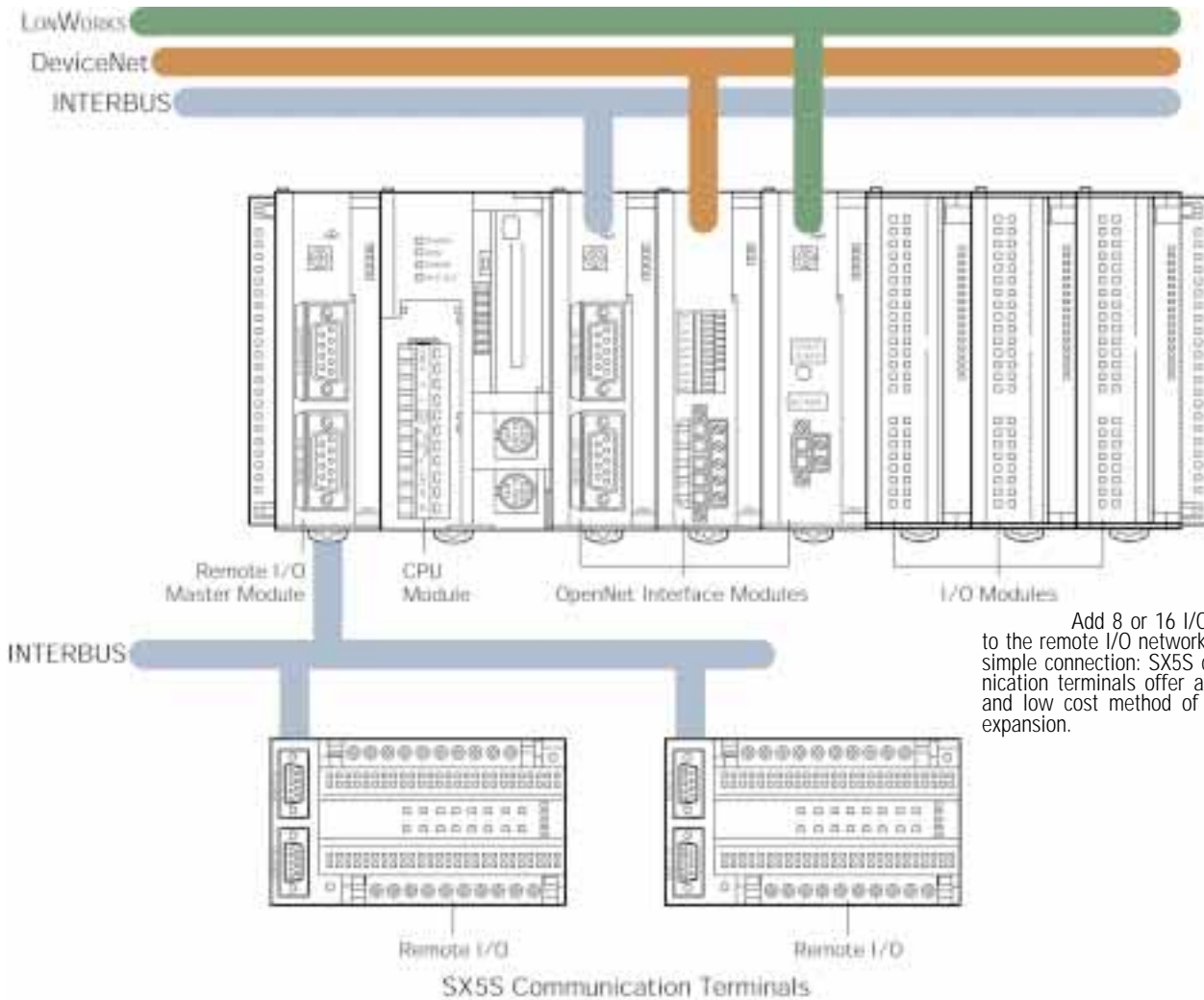

## OpenNet Interface Modules

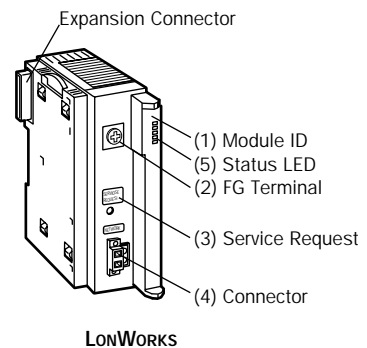
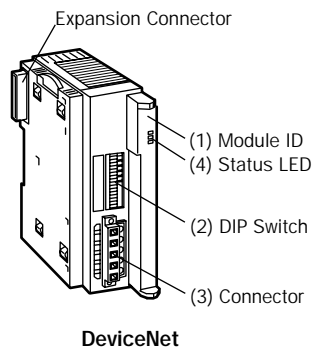
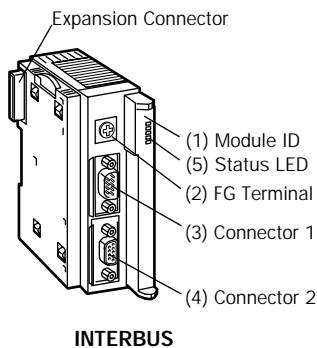

# Analog Input and Output Modules

## Key Features

- One card handles 5 different signal types, [ $\pm 5V$ ,  $\pm 10V$ , 0-5V, 0-10V, or 4-20mA], switch selectable
- Input module has 6 inputs per card, 7 cards per CPU, 42 analog input points maximum
- Output module has 2 outputs per card, 7 cards per CPU, 14 analog output points maximum
- 12-bit resolution, 0-4000 counts, count range divides evenly
- Fast input conversion, 3ms + 1 scan time
- I/O error  $\pm 0.6\%$  full scale @ 25°C
- Convenient input termination, Phoenix Contact type connector

## General Specifications

Analog Type	Input	Output
Point Per Card	6 Points	2 Points
Part Number	FC3A-AD1261	FC3A-DA1221
Connector Type	Phoenix Contact	Phoenix Contact
Input Signal	0-10V DC, $\pm 10V$ DC, 0-5V DC, $\pm 5V$ DC, 4-20mA	0-10V DC, $\pm 10V$ DC, 0-5V DC, $\pm 5V$ DC, 4-20mA
Resolution	12 bits	12 bits
Range	0-4000 counts	0-4000 counts
Input Error	$\pm 0.6\%$ of full scale @ 25°C	NA
Output Error	NA	$\pm 0.6\%$ of full scale @ 25°C
Conversion Time	3ms per point	NA
Settling Time	NA	3ms
Input Impedance	Voltage: 1 M $\Omega$ minimum Current: 250 $\Omega$	NA
Output Load Impedance	NA	Voltage=2 k $\Omega$ minimum (Current=250 $\Omega$ , 300 $\Omega$ max.)
Internal Current Draw	120mA@24V DC	120mA@24V DC



Analog Output Module  
FC3A-DA1221

## Type of Protection

Analog Input Module

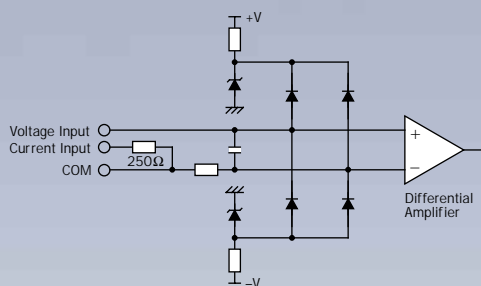

Analog Output Module

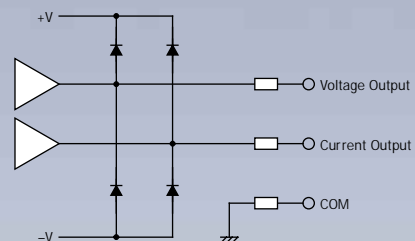

idec

### FC3A-AD1261 Analog Input Module Terminal Arrangement

6-Channel - Screw Terminal Type

Applicable Connector: SMSTB2.5/20-ST-5.08 (Phoenix Contact)

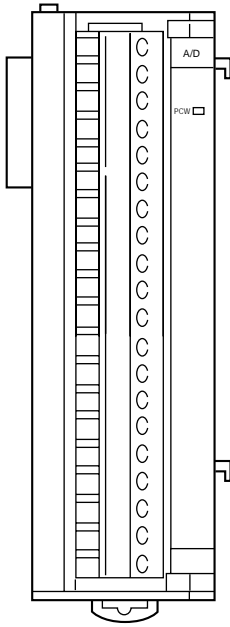

Terminal No.	Channel	Name
1	Channel 0	+V (voltage)
2		+I (current)
3		COM (-V, -I)
4	Channel 1	+V (voltage)
5		+I (current)
6		COM (-V, -I)
7	Channel 2	+V (voltage)
8		+I (current)
9		COM (-V, -I)
10	Channel 3	+V (voltage)
11		+I (current)
12		COM (-V, -I)
13	Channel 4	+V (voltage)
14		+I (current)
15		COM (-V, -I)
16	Channel 5	+V (voltage)
17		+I (current)
18		COM (-V, -I)
19	—	NC
20	—	NC

### FC3A-DA1221 Analog Output Module Terminal Arrangement

2-Channel - Screw Terminal Type

Applicable Connector: SMSTB2.5/20-ST-5.08 (Phoenix Contact)

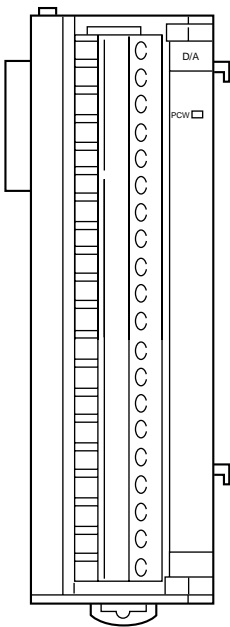

Terminal No.	Channel	Rotary Switch Position	Name
1	Channel 0	0	Voltage Output (0 to 10V)
2			COM (GND)
3		1	Voltage Output ( $\pm 10V$ )
4			COM (GND)
5		2	Voltage Output (0 to 5V)
6			COM (GND)
7		3	Voltage Output ( $\pm 5V$ )
8			COM (GND)
9		4	Current Output (4 to 20mA)
10			COM (GND)
11	Channel 1	0	Voltage Output (0 to 10V)
12			COM (GND)
13		1	Voltage Output ( $\pm 10V$ )
14			COM (GND)
15		2	Voltage Output (0 to 5V)
16			COM (GND)
17		3	Voltage Output ( $\pm 5V$ )
18			COM (GND)
19		4	Current Output (4 to 20mA)
20			COM (GND)

# 16-Point DC Input Modules



DC Input Module  
FC3A-N16B1  
FC3A-N16B3

## Key Features

- One card handles sink (NPN) or source (PNP) type input signals
- 16 points per card, 7 cards local, 8 cards expansion, 15 cards max. per CPU
- 19-30V DC input voltage range
- Software selectable input filtering, 0-32 msec
- High-speed catch inputs, first 8 points user definable, pulse detection within 20-120µsec range
- Termination connector
  - FC3A-N16B1 - removable Phoenix Contact type
  - FC3A-N16B3 - removable Nylon type

## General Specifications

Input Type	DC Sink/Source	
	FC3A-N16B1	FC3A-N16B3
Part Number	FC3A-N16B1	FC3A-N16B3
Connector Type	Phoenix Contact	Nylon
Input Voltage Range	19-30V DC	19-30V DC
Rated Input Voltage	24V DC	24V DC
Current Per Point	7mA	7mA
Internal Current - all inputs ON	40mA	40mA
Input Impedance	3.4kΩ	3.4kΩ
On/Off Voltage	15/5V DC	15/5V DC
On/Off Time	20/120µs	20/120µs

## Input Operating Range

The input operating range of the Type 1 (EN61131) input module is shown below:

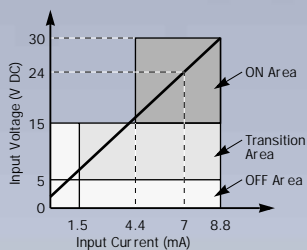

## Input Internal Circuit

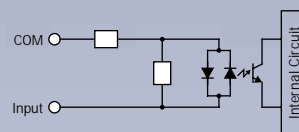

### FC3A-N16B1 Input Module Terminal Arrangement

16-Point DC - Screw Terminal Type

Applicable Connector: SMSTB2.5/20-ST-5.08 (Phoenix Contact)

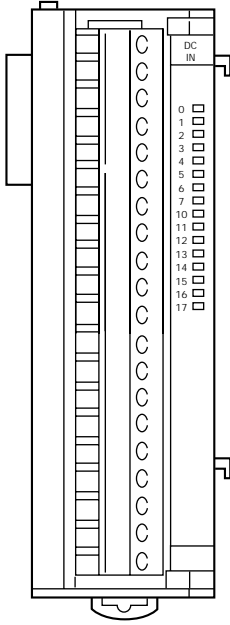

Terminal No.	Name
1	COM
2	COM
3	I0
4	I1
5	I2
6	I3
7	I4
8	I5
9	I6
10	I7
11	COM
12	COM
13	I10
14	I11
15	I12
16	I13
17	I14
18	I15
19	I16
20	I17

### FC3A-N16B3 Input Module Terminal Arrangement

16-Point DC - Nylon Connector Type

Applicable Connectors: VHR-10N (J.S.T. Mfg.)  
SVH-21T-P1.1 (J.S.T. Mfg.)

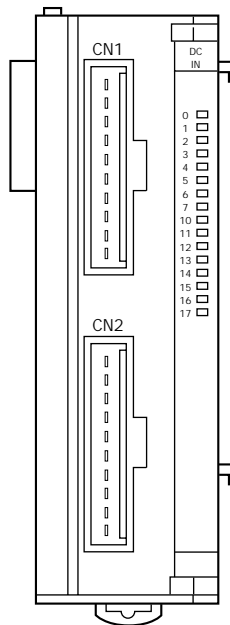

Terminal No.	CN1
1	COM
2	COM
3	I0
4	I1
5	I2
6	I3
7	I4
8	I5
9	I6
10	I7

Terminal No.	CN2
1	COM
2	COM
3	I10
4	I11
5	I12
6	I13
7	I14
8	I15
9	I16
10	I17

# 32-Point DC Input Modules

## Key Features

- One card handles sink (NPN) or source (PNP) type input signals
- 32 points per card, 7 cards local, 8 cards expansion, 15 cards max. per CPU
- 20-28V DC input voltage range
- Software selectable input filtering, 0-32 msec
- High-speed catch inputs, first 8 points user definable, pulse detection within 20-120µsec range
- Termination connector
  - FC3A-N32B4 - removable Nylon type
  - FC3A-N32B5 - removable Fujitsu type

## General Specifications

Input Type	DC Sink/Source	
Part Number	FC3A-N32B4	FC3A-N32B5
Connector Type	Nylon	Fujitsu
Input Voltage Range	20-28V DC	20-28V DC
Rated Input Voltage	24V DC	24V DC
Current Per Point	5mA	5mA
Internal Current -all inputs ON	50mA	50mA
Input Impedance	4.7kΩ	4.7kΩ
On/Off Voltage	15/5V DC	15/5V DC
On/Off Time	20/120µs	20/120µs



DC Input Module  
FC3A-N32B4  
FC3A-N32B5

## Input Operating Range

The input operating range of the Type 1 (EN61131) input module is shown below:

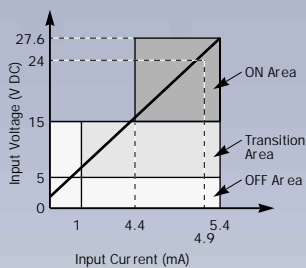

## Input Internal Circuit

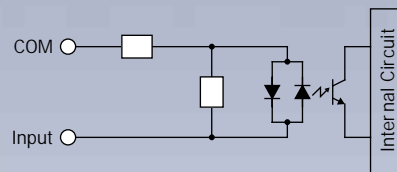

### FC3A-N32B4 Input Module Terminal Arrangement

32-Point DC - Nylon Connector Type

Applicable Connectors: H18-SHF-AA (J.S.T. Mfg.)  
SHF-001T-0.8BS (J.S.T. Mfg.)

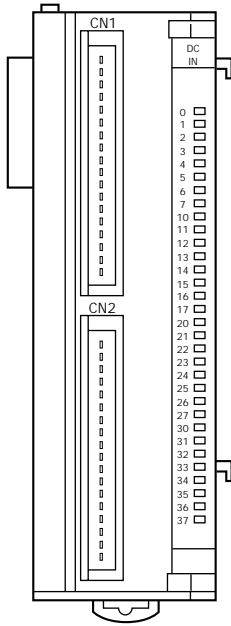

Terminal No.	CN1	CN2
18	I0	I20
17	I1	I21
16	I2	I22
15	I3	I23
14	I4	I24
13	I5	I25
12	I6	I26
11	I7	I27
10	I10	I30
9	I11	I31
8	I12	I32
7	I13	I33
6	I14	I34
5	I15	I35
4	I16	I36
3	I17	I37
2	COM	COM
1	COM	COM

### FC3A-N32B5 Input Module Terminal Arrangement

32-Point DC - Fujitsu Connector Type

Applicable Connector: FCN-367J040-AU (Fujitsu)

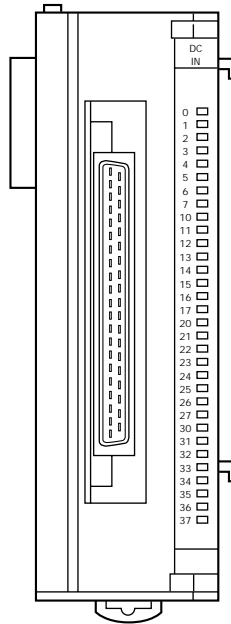

Terminal No.	Name
B20	I0
B19	I1
B18	I2
B17	I3
B16	I4
B15	I5
B14	I6
B13	I7
B12	I10
B11	I11
B10	I12
B9	I13
B8	I14
B7	I15
B6	I16
B5	I17
B4	NC
B3	NC
B2	COM
B1	COM

Terminal No.	Name
A20	I20
A19	I21
A18	I22
A17	I23
A16	I24
A15	I25
A14	I26
A13	I27
A12	I30
A11	I31
A10	I32
A9	I33
A8	I34
A7	I35
A6	I36
A5	I37
A4	NC
A3	NC
A2	NC
A1	NC

# 8-Point AC Input Module

## Key Features

- 8 points per card, 7 cards local, 8 cards expansion, 15 cards max. per CPU
- 100-120V AC rated input voltage
- 85-132V AC input voltage range
- On/off detection set at 20ms
- Convenient termination connector, removable Phoenix Contact type



AC Input Module  
FC3A-N08A11

## General Specifications

Input Type	AC
Part Number	FC3A-N08A11
Connector Type	Phoenix Contact
Input Voltage Range	85-132V AC
Rated Input Voltage	100-120V AC
Current Per Point	8mA
Internal Current - all inputs ON	30mA
Input Impedance	12 k $\Omega$ (60Hz)
On/Off Voltage	79/20V AC
On/Off Time	20ms

## Input Operating Range

The input operating range of the Type 1 (EN61131) input module is shown below:

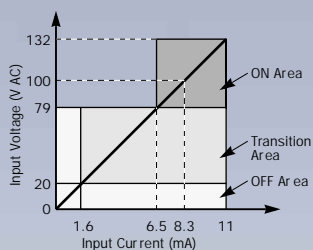

## Input Internal Circuit

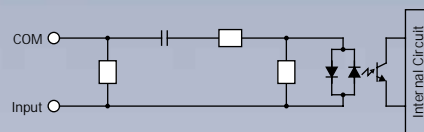

idec

### FC3A-N08A11 Input Module Terminal Arrangement

8-Point AC - Screw Terminal Type

Applicable Connector: SMSTB2.5/20-ST-5.08 (Phoenix Contact)

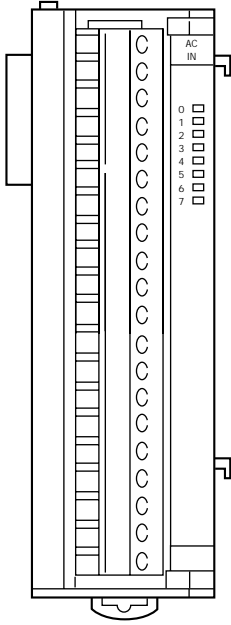

Terminal No.	Name
1	COM0
2	I0
3	COM1
4	I1
5	COM2
6	I2
7	COM3
8	I3
9	COM4
10	I4
11	COM5
12	I5
13	COM6
14	I6
15	COM7
16	I7
17	NC
18	NC
19	NC
20	NC

# 16-Point Relay Output Modules



Relay Output Module  
FC3A-R161  
FC3A-R162

## Key Features

- 16 points per card, 4 points per common, 15 cards max. per CPU
- Outputs rated 240V AC/2A or 24V DC/2A
- Turn On/Off delay 6-10ms
- 20,000,000 operations per relay minimum
- Termination connector
  - FC3A-R161 - removable Phoenix Contact type
  - FC3A-R162 - removable Nylon type

## General Specifications

Output Type	Relay Output	
	FC3A-R161	FC3A-R162
Part Number	FC3A-R161	FC3A-R162
Connector Type	Phoenix Contact	Nylon
Rated Output Voltage	240V AC/24V DC	240V AC/24V DC
Rated Current Per Point	2A	2A
Internal Current - all inputs ON	170mA	170mA
On/Off Time	6/10ms	6/10ms

## Output Delay

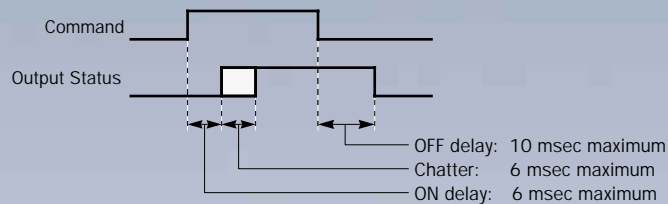

**idec**

### FC3A-R161 Output Module Terminal Arrangement

16-Point Relay - Screw Terminal Type

Applicable Connector: SMSTB2.5/20-ST-5.08 (Phoenix Contact)

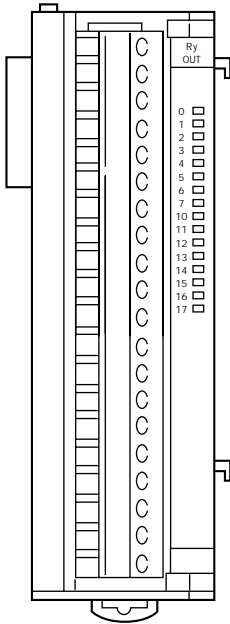

Terminal No.	Name
1	COM0
2	Q0
3	Q1
4	Q2
5	Q3
6	COM1
7	Q4
8	Q5
9	Q6
10	Q7
11	COM2
12	Q10
13	Q11
14	Q12
15	Q13
16	COM3
17	Q14
18	Q15
19	Q16
20	Q17

### FC3A-R162 Output Module Terminal Arrangement

16-Point Relay - Nylon Connector Type

Applicable Connectors: VHR-5N (J.S.T. Mfg.)

SVH-21T-P1.1 (J.S.T. Mfg.)

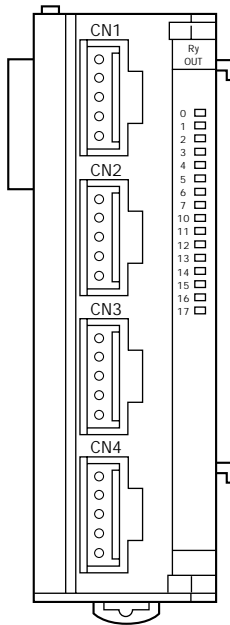

Terminal No.	CN1
1	COM0
2	Q0
3	Q1
4	Q2
5	Q3

Terminal No.	CN3
1	COM2
2	Q10
3	Q11
4	Q12
5	Q13

Terminal No.	CN2
1	COM1
2	Q4
3	Q5
4	Q6
5	Q7

Terminal No.	CN1
1	COM3
2	Q14
3	Q15
4	Q16
5	Q17

# 16-Point DC Sink Output Modules

## Key Features

- 16 transistor sink outputs per card, 15 cards max. per CPU
- Outputs rated 19-30V DC/0.5A
- Turn On/Off delay 500µsec max.
- Opto-isolated outputs
- Termination connector
  - FC3A-T16K1 - removable Phoenix Contact type
  - FC3A-T16K3 - removable Nylon type

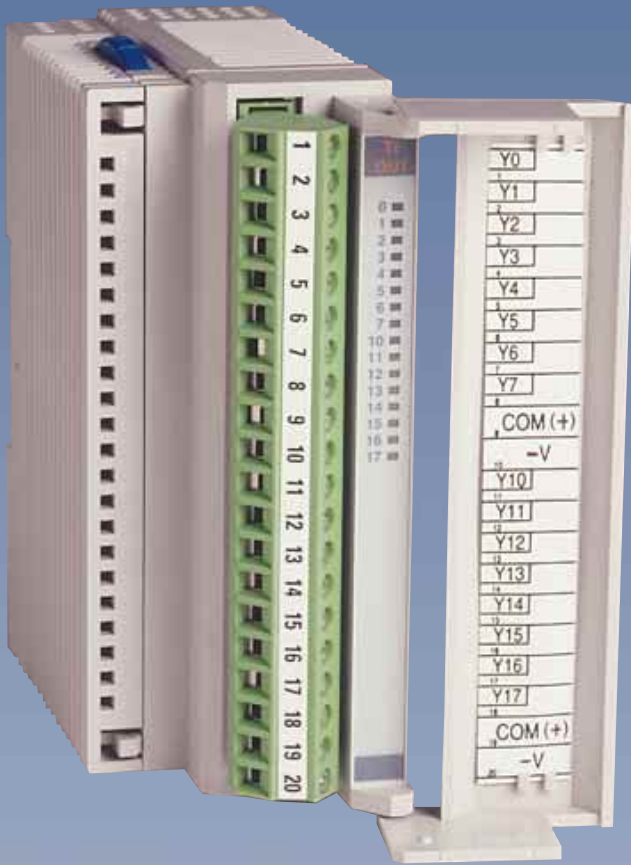

DC Sink Output Module  
FC3A-T16K1

## General Specifications

Output Type	DC Sink	
Part Number	FC3A-T16K1	FC3A-T16K3
Connector Type	Phoenix Contact	Nylon
Rated Output Voltage	19-30V DC	19-30V DC
Rated Current Per Point	500mA@ 24V DC	500mA@ 24V DC
Internal Current - all inputs ON	60mA	60mA
On/Off Time	500/500µs	500/500µs

### Output Delay

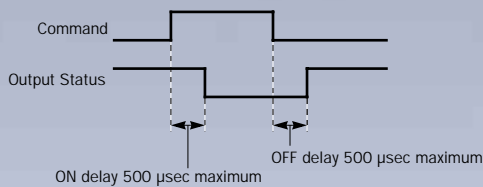

### Output Internal Circuit

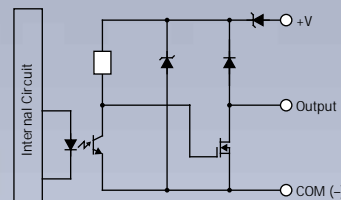

idec

### FC3A-T16K1 Sink Output Module Terminal Arrangement

16-Point DC - Screw Terminal Type

Applicable Connector: SMSTB2.5/20-ST-5.08 (Phoenix Contact)

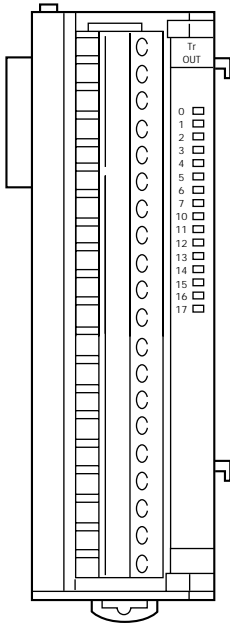

Terminal No.	Name
1	Q0
2	Q1
3	Q2
4	Q3
5	Q4
6	Q5
7	Q6
8	Q7
9	COM(-)
10	+V
11	Q10
12	Q11
13	Q12
14	Q13
15	Q14
16	Q15
17	Q16
18	Q17
19	COM(-)
20	+V

### FC3A-T16K3 Sink Output Module Terminal Arrangement

16-Point DC - Nylon Connector Type

Applicable Connectors: VHR-10N (J.S.T. Mfg.)  
SVH-21T-P1.1 (J.S.T. Mfg.)

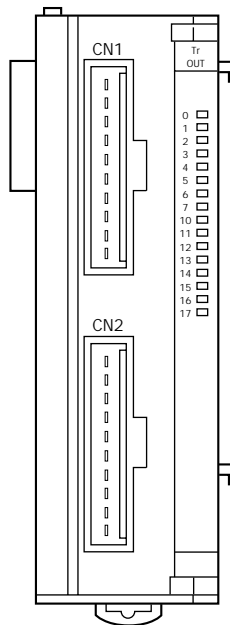

Terminal No.	CN1
1	Q0
2	Q1
3	Q2
4	Q3
5	Q4
6	Q5
7	Q6
8	Q7
9	COM(-)
10	+V

Terminal No.	CN2
1	Q10
2	Q11
3	Q12
4	Q13
5	Q14
6	Q15
7	Q16
8	Q17
9	COM(-)
10	+V

# 16-Point DC Protect Source Output Module



Protect Source Output Module  
FC3A-T16P1

## Key Features

- 16 transistor protect source outputs per card, 15 cards max. per CPU
- Outputs rated 19-30V DC/0.5A
- Turn On/Off delay 500 $\mu$ sec max.
- Opto-isolated outputs
- Termination connector, removable Phoenix Contact type

## General Specifications

Output Type	DC Source
Part Number	FC3A-T16P1
Connector Type	Phoenix Contact
Rated Output Voltage	19-30V DC
Rated Current Per Point	500mA @ 24V DC
Internal Current - all inputs ON	70mA
On/Off Time	500 $\mu$ s/500 $\mu$ s

## Output Delay

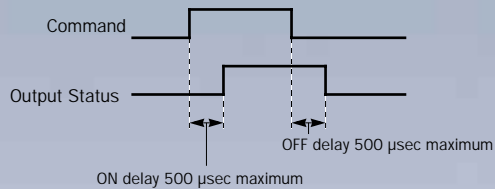

## Output Internal Circuit

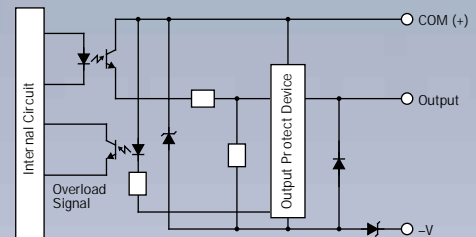

idec

### FC3A-T16P1 Protect Source Output Module Terminal Arrangement

16-Point DC - Screw Terminal Type

Applicable Connector: SMSTB2.5/20-ST-5.08 (Phoenix Contact)

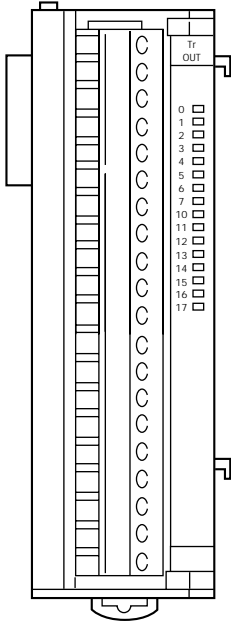

Terminal No.	Name
1	Q0
2	Q1
3	Q2
4	Q3
5	Q4
6	Q5
7	Q6
8	Q7
9	COM(+)
10	-V
11	Q10
12	Q11
13	Q12
14	Q13
15	Q14
16	Q15
17	Q16
18	Q17
19	COM(+)
20	-V

# 32-Point DC Sink Output Modules



DC Sink Output Module  
FC3A-T32K4

## Key Features

- 32 transistor sink outputs per card, 15 cards max. per CPU
- Outputs rated 20.4-27.6V DC/0.1A
- Turn On/Off delay 500µsec max.
- Opto-isolated outputs
- Termination connector
  - FC3A-T32K4 - removable Nylon type
  - FC3A-T32K5 - removable Fujitsu type

## General Specifications

Output Type	DC Sink	
Part Number	FC3A-T32K4	FC3A-T32K5
Connector Type	Nylon	Fujitsu
Rated Output Voltage	20.4-27.6V DC	20.4-27.6V DC
Rated Current Per Point	100mA@24V DC	100mA@24V DC
Internal Current - all inputs ON	90mA	90mA
On/Off Time	500/500µs	500/500µs

## Output Delay

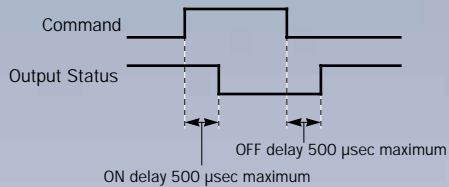

## Output Internal Circuit

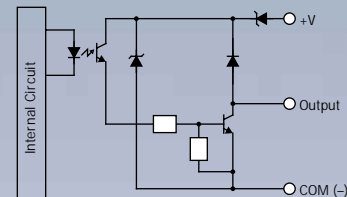

idec

### FC3A-T32K4 Sink Output Module Terminal Arrangement

32-Point DC - Nylon Connector Type

Applicable Connectors: H18-SHF-AA (J.S.T. Mfg.)  
SHF-001T-0.8BS (J.S.T. Mfg.)

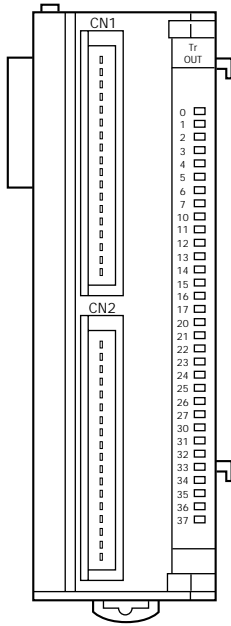

Terminal No.	CN1	CN2
18	Q0	Q20
17	Q1	Q21
16	Q2	Q22
15	Q3	Q23
14	Q4	Q24
13	Q5	Q25
12	Q6	Q26
11	Q7	Q27
10	Q10	Q30
9	Q11	Q31
8	Q12	Q32
7	Q13	Q33
6	Q14	Q34
5	Q15	Q35
4	Q16	Q36
3	Q17	Q37
2	COM(-)	COM(-)
1	+V	+V

### FC3A-T32K5 Sink Output Module Terminal Arrangement

32-Point DC - Fujitsu Connector Type

Applicable Connector: FCN-367J040-AU (Fujitsu)

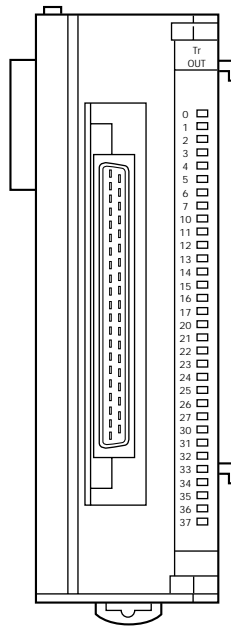

Terminal No.	Name
B20	Q0
B19	Q1
B18	Q2
B17	Q3
B16	Q4
B15	Q5
B14	Q6
B13	Q7
B12	Q10
B11	Q11
B10	Q12
B9	Q13
B8	Q14
B7	Q15
B6	Q16
B5	Q17
B4	NC
B3	NC
B2	+V
B1	+V

Terminal No.	Name
A20	Q20
A19	Q21
A18	Q22
A17	Q23
A16	Q24
A15	Q25
A14	Q26
A13	Q27
A12	Q30
A11	Q31
A10	Q32
A9	Q33
A8	Q34
A7	Q35
A6	Q36
A5	Q37
A4	NC
A3	NC
A2	COM(-)
A1	COM(-)

# Expansion Power Supply Module

## Key Features

- Expands the ONC from 224 up to 480 I/O points
- Increases I/O and functional modules by 8
- Comes with a cable connector and contacts
- Simple, easy and convenient mounting
- Install in the 8 slot only



Expansion Module  
FC3A-EA1

## General Specifications

### Specifications

Part Number	FC3A-EA1
Connector Type	Nylon - 5 pin
Input Voltage Range	19 - 30V DC (including ripple)
Rated Input Voltage	24V DC
Internal Current	30mA
Momentary Power Interruption	10 msec (24V DC), Level PS-2 (EN61131)

## Power Supply Wiring

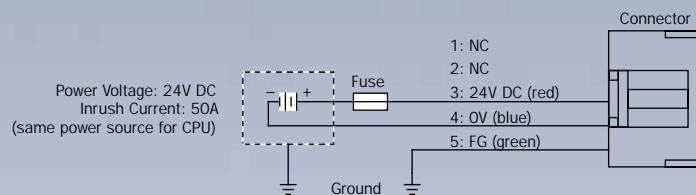

idec

### FC3A-EA1 Expansion Power Supply Module Mounting Position

Mount the expansion power supply module in the eighth slot.

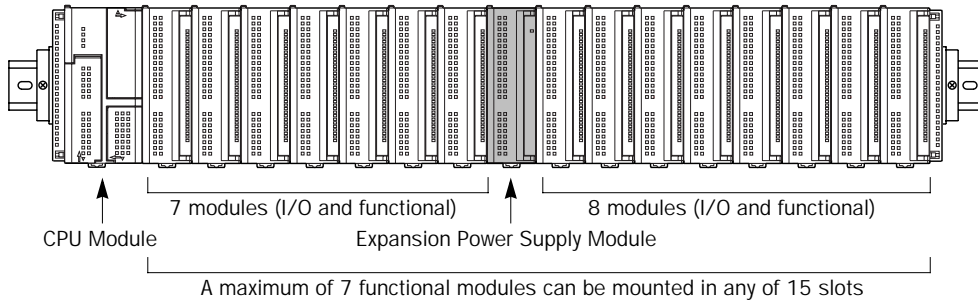

*Mount the expansion power supply module only in the eighth slot, otherwise correct allocation of I/O and link register numbers may not occur.*